

# Brief Contents

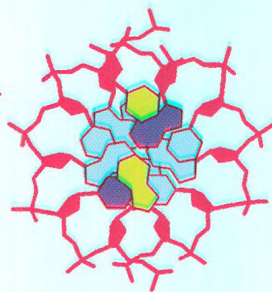

## PART I THE MOLECULAR DESIGN OF LIFE

- Chapter 1 Prelude 3
- Chapter 2 Biochemical Evolution 19
- Chapter 3 Protein Structure and Function 41
- Chapter 4 Exploring Proteins 77
- Chapter 5 RNA, DNA, and the Flow of Genetic Information 117
- Chapter 6 Exploring Genes 143
- Chapter 7 Exploring Evolution (including Bioinformatics) 171
- Chapter 8 Enzymes: Basic Concepts and Kinetics 189
- Chapter 9 Catalytic Strategies 227
- Chapter 10 Regulatory Strategies: Enzymes and Hemoglobin 261
- Chapter 11 Carbohydrates 295
- Chapter 12 Lipids and Cell Membranes 319
- Chapter 13 Membrane Channels and Pumps 345

## PART II TRANSDUCING AND STORING ENERGY

- Chapter 14 Metabolism: Basic Concepts and Design 373
- Chapter 15 Signal-Transduction Pathways: An Introduction to Information Metabolism 395
- Chapter 16 Glycolysis and Gluconeogenesis 425
- Chapter 17 The Citric Acid Cycle 465

- Chapter 18 Oxidative Phosphorylation 491
- Chapter 19 The Light Reactions of Photosynthesis 527
- Chapter 20 The Calvin Cycle and the Pentose Phosphate Pathway 551
- Chapter 21 Glycogen Metabolism 577
- Chapter 22 Fatty Acid Metabolism 601
- Chapter 23 Protein Turnover and Amino Acid Catabolism 633

## PART III SYNTHESIZING THE MOLECULES OF LIFE

- Chapter 24 The Biosynthesis of Amino Acids 665
- Chapter 25 Nucleotide Biosynthesis 693
- Chapter 26 The Biosynthesis of Membrane Lipids and Steroids 715
- Chapter 27 DNA Replication, Recombination, and Repair 745
- Chapter 28 RNA Synthesis and Splicing 781
- Chapter 29 Protein Synthesis 813
- Chapter 30 The Integration of Metabolism 845
- Chapter 31 The Control of Gene Expression 867

## PART IV RESPONDING TO ENVIRONMENTAL CHANGES

- Chapter 32 Sensory Systems
- Chapter 33 The Immune System
- Chapter 34 Molecular Motors

# Contents

Preface	v
Tools and Techniques	x
Clinical Applications	xi
Molecular Evolution	xii
Acknowledgments	xv

## PART I THE MOLECULAR DESIGN OF LIFE

### CHAPTER 1 Prelude: Biochemistry and the Genomic Revolution 3

#### 1.1 DNA Illustrates the Relation Between Form and Function 4

##### 1.1.1 DNA Is Constructed from Four Building Blocks 4

##### 1.1.2 Two Single Strands of DNA Combine to Form a Double Helix 5

##### 1.1.3 RNA Is an Intermediate in the Flow of Genetic Information 6

##### 1.1.4 Proteins, Encoded by Nucleic Acids, Perform Most Cell Functions 6

#### 1.2 Biochemical Unity Underlies Biological Diversity 7

#### 1.3 Chemical Bonds in Biochemistry 8

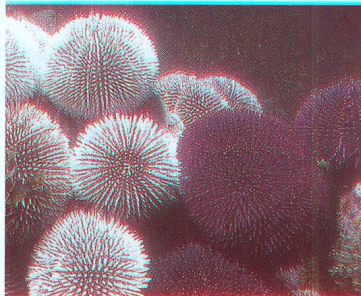

##### 1.3.1 Reversible Interactions of Biomolecules Are Mediated by Three Kinds of Noncovalent Bonds 9

##### 1.3.2 The Properties of Water Affect the Bonding Abilities of Biomolecules 10

##### 1.3.3 Entropy and the Laws of Thermodynamics 11

##### 1.3.4 Protein Folding Can Be Understood in Terms of Free-Energy Changes 14

#### 1.4 Biochemistry and Human Biology 15

##### Appendix: Depicting Molecular Structures 16

### CHAPTER 2 Biochemical Evolution 19

#### 2.1 Key Organic Molecules Are Used by Living Systems 20

##### 2.1.1 Many Components of Biochemical Macromolecules Can Be Produced in Simple, Prebiotic Reactions 20

##### 2.1.2 Uncertainties Obscure the Origins of Some Key Biomolecules 21

#### 2.2 Evolution Requires Reproduction, Variation, and Selective Pressure 21

##### 2.2.1 The Principles of Evolution Can Be Demonstrated in Vitro 22

##### 2.2.2 RNA Molecules Can Act As Catalysts 23

##### 2.2.3 Amino Acids and Their Polymers Can Play Biosynthetic and Catalytic Roles 23

##### 2.2.4 RNA Template-Directed Polypeptide Synthesis Links the RNA and Protein Worlds 24

##### 2.2.5 The Genetic Code Elucidates the Mechanisms of Evolution 25

##### 2.2.6 Transfer RNAs Illustrate Evolution by Gene Duplication 26

##### 2.2.7 DNA Is a Stable Storage Form for Genetic Information 26

#### 2.3 Energy Transformations Are Necessary to Sustain Living Systems 28

##### 2.3.1 ATP, a Common Currency for Biochemical Energy, Can Be Generated Through the Breakdown of Organic Molecules 28

##### 2.3.2 Cells Were Formed by the Inclusion of Nucleic Acids Within Membranes 29

##### 2.3.3 Compartmentalization Required the Development of Ion Pumps 30

##### 2.3.4 Proton Gradients Can Be Used to Drive the Synthesis of ATP 31

##### 2.3.5 Molecular Oxygen, a Toxic By-Product of Some Photosynthetic Processes, Can Be Utilized for Metabolic Purposes 32

#### 2.4 Cells Can Respond to Changes in Their Environments 33

##### 2.4.1 Filamentous Structures and Molecular Motors Enable Intracellular and Cellular Movement 34

##### 2.4.2 Some Cells Can Interact to Form Colonies with Specialized Functions 35

##### 2.4.3 The Development of Multicellular Organisms Requires the Orchestrated Differentiation of Cells 36

##### 2.4.4 The Unity of Biochemistry Allows Human Biology to Be Effectively Probed Through Studies of Other Organisms 37

### CHAPTER 3 Protein Structure and Function 41

#### 3.1 Proteins Are Built from a Repertoire of 20 Amino Acids 43

#### 3.2 Primary Structure: Amino Acids Are Linked by Peptide Bonds to Form Polypeptide Chains 51

##### 3.2.1 Proteins Have Unique Amino Acid Sequences That Are Specified by Genes 53

##### 3.2.2 Polypeptide Chains Are Flexible Yet Conformationally Restricted 54

**3.3 Secondary Structure: Polypeptide Chains Can Fold into Regular Structures Such as the Alpha Helix, the Beta Sheet, and Turns and Loops** 56

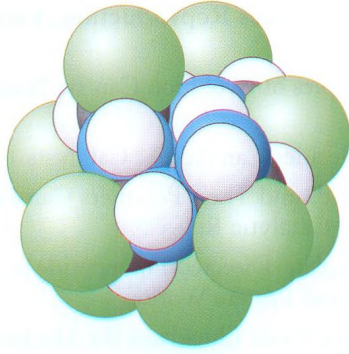

3.3.1 The Alpha Helix Is a Coiled Structure Stabilized by Intrachain Hydrogen Bonds 56

3.3.2 Beta Sheets Are Stabilized by Hydrogen Bonding Between Polypeptide Strands 58

3.3.3 Polypeptide Chains Can Change Direction by Making Reverse Turns and Loops 60

**3.4 Tertiary Structure: Water-Soluble Proteins Fold into Compact Structures with Nonpolar Cores** 61

**3.5 Quaternary Structure: Polypeptide Chains Can Assemble into Multisubunit Structures** 63

**3.6 The Amino Acid Sequence of a Protein Determines Its Three-Dimensional Structure** 64

3.6.1 Amino Acids Have Different Propensities for Forming Alpha Helices, Beta Sheets, and Beta Turns 66

3.6.2 Protein Folding Is a Highly Cooperative Process 68

3.6.3 Proteins Fold by Progressive Stabilization of Intermediates Rather than by Random Search 68

3.6.4 Prediction of Three-Dimensional Structure from Sequence Remains a Great Challenge 69

3.6.5 Protein Modification and Cleavage Confer New Capabilities 69

Appendix: Acid–Base Concepts 73

**CHAPTER 4 Exploring Proteins** 77

4.0.1 The Proteome Is the Functional Representation of the Genome 78

**4.1 The Purification of Proteins Is an Essential First Step in Understanding Their Function** 78

4.1.1 The Assay: How Do We Recognize the Protein That We Are Looking For? 78

4.1.2 Proteins Must Be Released from the Cell to Be Purified 79

4.1.3 Proteins Can Be Purified According to Solubility, Size, Charge, and Binding Affinity 80

4.1.4 Proteins Can Be Separated by Gel Electrophoresis and Displayed 83

4.1.5 A Protein Purification Scheme Can Be Quantitatively Evaluated 86

4.1.6 Ultracentrifugation Is Valuable for Separating Biomolecules and Determining Their Masses 87

4.1.7 The Mass of a Protein Can Be Precisely Determined by Mass Spectrometry 89

**4.2 Amino Acid Sequences Can Be Determined by Automated Edman Degradation** 91

4.2.1 Proteins Can Be Specifically Cleaved into Small Peptides to Facilitate Analysis 94

4.2.2 Amino Acid Sequences Are Sources of Many Kinds of Insights 96

4.2.3 Recombinant DNA Technology Has Revolutionized Protein Sequencing 97

**4.3 Immunology Provides Important Techniques with Which to Investigate Proteins** 98

4.3.1 Antibodies to Specific Proteins Can Be Generated 98

4.3.2 Monoclonal Antibodies with Virtually Any Desired Specificity Can Be Readily Prepared 100

4.3.3 Proteins Can Be Detected and Quantitated by Using an Enzyme-Linked Immunosorbent Assay 101

4.3.4 Western Blotting Permits the Detection of Proteins Separated by Gel Electrophoresis 103

4.3.5 Fluorescent Markers Make Possible the Visualization of Proteins in the Cell 103

**4.4 Peptides Can Be Synthesized by Automated Solid-Phase Methods** 104

**4.5 Three-Dimensional Protein Structure Can Be Determined by NMR Spectroscopy and X-Ray Crystallography** 107

4.5.1 Nuclear Magnetic Resonance Spectroscopy Can Reveal the Structures of Proteins in Solution 107

4.5.2 X-Ray Crystallography Reveals Three-Dimensional Structure in Atomic Detail 110

**CHAPTER 5 DNA, RNA, and the Flow of Genetic Information** 117

**5.1 A Nucleic Acid Consists of Four Kinds of Bases Linked to a Sugar-Phosphate Backbone** 118

5.1.1 RNA and DNA Differ in the Sugar Component and One of the Bases 118

5.1.2 Nucleotides Are the Monomeric Units of Nucleic Acids 120

**5.2 A Pair of Nucleic Acid Chains with Complementary Sequences Can Form a Double-Helical Structure** 121

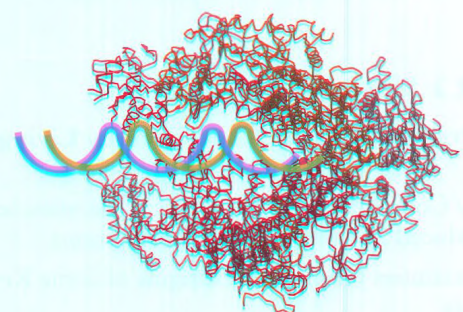

5.2.1 The Double Helix Is Stabilized by Hydrogen Bonds and Hydrophobic Interactions	121	6.2.1 Restriction Enzymes and DNA Ligase Are Key Tools in Forming Recombinant DNA Molecules	152
5.2.2 The Double Helix Facilitates the Accurate Transmission of Hereditary Information	123	6.2.2 Plasmids and Lambda Phage Are Choice Vectors for DNA Cloning in Bacteria	153
5.2.3 The Double Helix Can Be Reversibly Melted	124	6.2.3 Specific Genes Can Be Cloned from Digests of Genomic DNA	155
5.2.4 Some DNA Molecules Are Circular and Supercoiled	125	6.2.4 Long Stretches of DNA Can Be Efficiently Analyzed by Chromosome Walking	156
5.2.5 Single-Stranded Nucleic Acids Can Adopt Elaborate Structures	126	<b>6.3 Manipulating the Genes of Eukaryotes</b>	<b>157</b>
<b>5.3 DNA Is Replicated by Polymerases That Take Instructions from Templates</b>	<b>127</b>	6.3.1 Complementary DNA (cDNA) Prepared from mRNA Can Be Expressed in Host Cells	157
5.3.1 DNA Polymerase Catalyzes Phosphodiester-Bond Formation	127	6.3.2 Gene-Expression Levels Can Be Comprehensively Examined	159
5.3.2 The Genes of Some Viruses Are Made of RNA	128	6.3.3 New Genes Inserted into Eukaryotic Cells Can Be Efficiently Expressed	160
<b>5.4 Gene Expression Is the Transformation of DNA Information into Functional Molecules</b>	<b>129</b>	6.3.4 Transgenic Animals Harbor and Express Genes That Were Introduced into Their Germ Lines	161
5.4.1 Several Kinds of RNA Play Key Roles in Gene Expression	129	6.3.5 Gene Disruption Provides Clues to Gene Function	162
5.4.2 All Cellular RNA Is Synthesized by RNA Polymerases	130	6.3.6 Tumor-Inducing Plasmids Can Be Used to Introduce New Genes into Plant Cells	163
5.4.3 RNA Polymerases Take Instructions from DNA Templates	131	<b>6.4 Novel Proteins Can Be Engineered by Site-Specific Mutagenesis</b>	<b>164</b>
5.4.4 Transcription Begins Near Promoter Sites and Ends at Terminator Sites	131	6.4.1 Proteins with New Functions Can Be Created Through Directed Changes in DNA	164
5.4.5 Transfer RNA Is the Adaptor Molecule in Protein Synthesis	132	6.4.2 Recombinant DNA Technology Has Opened New Vistas	165
<b>5.5 Amino Acids Are Encoded by Groups of Three Bases Starting from a Fixed Point</b>	<b>133</b>	<hr/> <b>CHAPTER 7 Exploring Evolution (Including Bioinformatics)</b>	<b>171</b>
5.5.1 Major Features of the Genetic Code	134	<b>7.1 Homologs Are Descended from a Common Ancestor</b>	<b>173</b>
5.5.2 Messenger RNA Contains Start and Stop Signals for Protein Synthesis	135	<b>7.2 Statistical Analysis of Sequence Alignments Can Detect Homology</b>	<b>173</b>
5.5.3 The Genetic Code Is Nearly Universal	135	7.2.1. The Statistical Significance of Alignments Can Be Estimated by Shuffling	175
<b>5.6 Most Eukaryotic Genes Are Mosaics of Introns and Exons</b>	<b>136</b>	7.2.2. Distant Evolutionary Relationships Can Be Detected Through the Use of Substitution Matrices	177
5.6.1 RNA Processing Generates Mature RNA	137	7.2.3. Databases Can Be Searched to Identify Homologous Sequences	178
5.6.2 Many Exons Encode Protein Domains	137	<b>7.3 Examination of Three-Dimensional Structure Enhances Our Understanding of Evolutionary Relationships</b>	<b>179</b>
<hr/> <b>CHAPTER 6 Exploring Genes</b>	<b>143</b>		
<b>6.1 The Basic Tools of Gene Exploration</b>	<b>144</b>	7.3.1 Tertiary Structure Is More Conserved Than Primary Structure	179
6.1.1 Restriction Enzymes Split DNA into Specific Fragments	144		
6.1.2 Restriction Fragments Can Be Separated by Gel Electrophoresis and Visualized	145		
6.1.3 DNA Is Usually Sequenced by Controlled Termination of Replication (Sanger Dideoxy Method)	146		
6.1.4 DNA Probes and Genes Can Be Synthesized by Automated Solid-Phase Methods	148		
6.1.5 Selected DNA Sequences Can Be Greatly Amplified by the Polymerase Chain Reaction	149		
6.1.6 PCR Is a Powerful Technique in Medical Diagnostics, Forensics, and Molecular Evolution	151		
<b>6.2 Recombinant DNA Technology Has Revolutionized All Aspects of Biology</b>	<b>151</b>		

7.3.2 Knowledge of Three-Dimensional Structures Can Aid in the Evaluation of Sequence Alignments 180

7.3.3 Repeated Motifs Can Be Detected by Aligning Sequences with Themselves 181

7.3.4 Convergent Evolution: Common Solutions to Biochemical Challenges 182

7.3.5 Comparison of RNA Sequences Can Be a Source of Insight into Secondary Structures 182

**7.4 Evolutionary Trees Can Be Constructed on the Basis of Sequence Information 183**

**7.5 Modern Techniques Make the Experimental Exploration of Evolution Possible 184**

7.5.1 Ancient DNA Can Sometimes Be Amplified and Sequenced 184

7.5.2 Molecular Evolution Can Be Examined Experimentally 184

**CHAPTER 8 Enzymes: Basic Concepts and Kinetics 189**

**8.1 Enzymes Are Powerful and Highly Specific Catalysts 190**

8.1.1 Many Enzymes Require Cofactors for Activity 191

8.1.2 Enzymes May Transform Energy from One Form into Another 192

8.1.3 Enzymes Are Classified on the Basis of the Types of Reaction That They Catalyze 192

**8.2 Free Energy Is a Useful Thermodynamic Function for Understanding Enzymes 193**

8.2.1 The Free-Energy Change Provides Information About the Spontaneity but Not the Rate of a Reaction 193

8.2.2 The Standard Free-Energy Change of a Reaction Is Related to the Equilibrium Constant 194

8.2.3 Enzymes Alter Only the Reaction Rate and Not the Reaction Equilibrium 196

**8.3 Enzymes Accelerate Reactions by Facilitating the Formation of the Transition State 196**

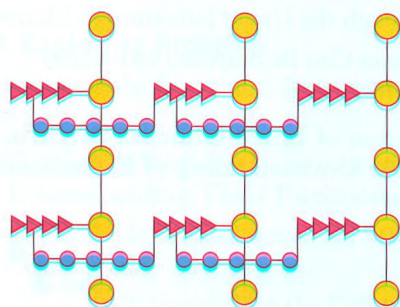

8.3.1 The Formation of an Enzyme-Substrate Complex Is the First Step in Enzymatic Catalysis 197

8.3.2 The Active Sites of Enzymes Have Some Common Features 198

**8.4. The Michaelis-Menten Model Accounts for the Kinetic Properties of Many Enzymes 200**

8.4.1 The Significance of  $K_M$  and  $V_{max}$  Values 203

8.4.2 Kinetic Perfection in Enzymatic Catalysis: The  $k_{cat}/K_M$  Criterion 205

8.4.3 Most Biochemical Reactions Include Multiple Substrates 207

8.4.4 Allosteric Enzymes Do Not Obey Michaelis-Menten Kinetics 208

**8.5 Enzymes Can Be Inhibited by Specific Molecules 209**

8.5.1 Competitive and Noncompetitive Inhibition Are Kinetically Distinguishable 210

8.5.2 Irreversible Inhibitors Can Be Used to Map the Active Site 210

8.5.3 Transition-State Analogs Are Potent Inhibitors of Enzymes 213

8.5.4 Catalytic Antibodies Demonstrate the Importance of Selective Binding of the Transition State to Enzymatic Activity 213

8.5.5 Penicillin Irreversibly Inactivates a Key Enzyme in Bacterial Cell-Wall Synthesis 214

**8.6 Vitamins Are Often Precursors to Coenzymes 216**

8.6.1 Water-Soluble Vitamins Function As Coenzymes 217

8.6.2 Fat-Soluble Vitamins Participate in Diverse Processes Such As Blood Clotting and Vision 219

Appendix:  $V_{max}$  and  $K_M$  Can Be Determined by Double-Reciprocal Plots 221

**CHAPTER 9 Catalytic Strategies 227**

9.0.1 A Few Basic Catalytic Principles Are Used by Many Enzymes 228

**9.1 Proteases: Facilitating a Difficult Reaction 228**

9.1.1 Chymotrypsin Possesses a Highly Reactive Serine Residue 229

9.1.2 Chymotrypsin Action Proceeds in Two Steps Linked by a Covalently Bound Intermediate 230

9.1.3 Serine Is Part of a Catalytic Triad That Also Includes Histidine and Aspartic Acid 231

9.1.4 Catalytic Triads Are Found in Other Hydrolytic Enzymes 234

9.1.5 The Catalytic Triad Has Been Dissected by Site-Directed Mutagenesis 236

9.1.6 Cysteine, Aspartyl, and Metalloproteases Are Other Major Classes of Peptide-Cleaving Enzymes 236

9.1.7 Protease Inhibitors Are Important Drugs 238

**9.2 Making a Fast Reaction Faster: Carbonic Anhydrases 239**

9.2.1 Carbonic Anhydrase Contains a Bound Zinc Ion Essential for Catalytic Activity 240

9.2.2 Catalysis Entails Zinc Activation of Water 241

9.2.3 A Proton Shuttle Facilitates Rapid Regeneration of the Active Form of the Enzyme 242

9.2.4 Convergent Evolution Has Generated Zinc-Based Active Sites in Different Carbonic Anhydrases 244

**9.3 Restriction Enzymes: Performing Highly Specific DNA-Cleavage Reactions 245**

9.3.1 Cleavage Is by In-Line Displacement of 3' Oxygen from Phosphorus by Magnesium-Activated Water 246

9.3.2 Restriction Enzymes Require Magnesium for Catalytic Activity 248

9.3.3 The Complete Catalytic Apparatus Is Assembled Only Within Complexes of Cognate DNA Molecules, Ensuring Specificity 248

9.3.4 Type II Restriction Enzymes Have a Catalytic Core in Common and Are Probably Related by Horizontal Gene Transfer 251

9.4 Nucleoside Monophosphate Kinases: Catalyzing Phosphoryl Group Exchange Between Nucleotides Without Promoting Hydrolysis 252

9.4.1 NMP Kinases Are a Family of Enzymes Containing P-Loop Structures 253

9.4.2 Magnesium (or Manganese) Complexes of Nucleotide Triphosphates Are the True Substrates for Essentially All NTP-Dependent Enzymes 254

9.4.3 ATP Binding Induces Large Conformational Changes 255

9.4.4 P-Loop NTPase Domains Are Present in a Range of Important Proteins 255

**CHAPTER 10 Regulatory Strategies: Enzymes and Hemoglobin 261**

10.1 Aspartate Transcarbamoylase Is Allosterically Inhibited by the End Product of Its Pathway 262

10.1.1 ATCase Consists of Separable Catalytic and Regulatory Subunits 263

10.1.2 Allosteric Interactions in ATCase Are Mediated by Large Changes in Quaternary Structure 264

10.1.3 Allosterically Regulated Enzymes Do Not Follow Michaelis-Menten Kinetics 267

10.1.4 Allosteric Regulators Modulate the T-to-R Equilibrium 267

10.1.5 The Concerted Model Can Be Formulated in Quantitative Terms 268

10.1.6 Sequential Models Also Can Account for Allosteric Effects 269

10.2 Hemoglobin Transports Oxygen Efficiently by Binding Oxygen Cooperatively 269

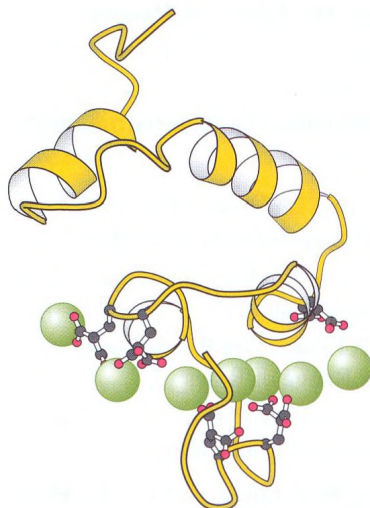

10.2.1 Oxygen Binding Induces Substantial Structural Changes at the Iron Sites in Hemoglobin 270

10.2.2 Oxygen Binding Markedly Changes the Quaternary Structure of Hemoglobin 271

10.2.3 Tuning the Oxygen Affinity of Hemoglobin: The Effect of 2,3-Bisphosphoglycerate 272

10.2.4 The Bohr Effect: Hydrogen Ions and Carbon Dioxide Promote the Release of Oxygen 273

10.3 Isozymes Provide a Means of Regulation Specific to Distinct Tissues and Developmental Stages 274

10.4 Covalent Modification Is a Means of Regulating Enzyme Activity 275

10.4.1 Phosphorylation Is a Highly Effective Means of Regulating the Activities of Target Proteins 276

10.4.2 Cyclic AMP Activates Protein Kinase A by Altering the Quaternary Structure 278

10.4.3 ATP and the Target Protein Bind to a Deep Cleft in the Catalytic Subunit of Protein Kinase A 279

10.5 Many Enzymes Are Activated by Specific Proteolytic Cleavage 280

10.5.1 Chymotrypsinogen Is Activated by Specific Cleavage of a Single Peptide Bond 281

10.5.2 Proteolytic Activation of Chymotrypsinogen Leads to the Formation of a Substrate-Binding Site 281

10.5.3 The Generation of Trypsin from Trypsinogen Leads to the Activation of Other Zymogens 282

10.5.4 Some Proteolytic Enzymes Have Specific Inhibitors 283

10.5.5 Blood Clotting Is Accomplished by a Cascade of Zymogen Activations 284

10.5.6 Fibrinogen Is Converted by Thrombin into a Fibrin Clot 285

10.5.7 Prothrombin Is Readied for Activation by a Vitamin K-Dependent Modification 287

10.5.8 Hemophilia Revealed an Early Step in Clotting 288

10.5.9 The Clotting Process Must Be Precisely Regulated 289

**CHAPTER 11 Carbohydrates 295**

11.1 Monosaccharides Are Aldehydes or Ketones with Multiple Hydroxyl Groups 296

11.1.1 Pentoses and Hexoses Cyclize to Form Furanose and Pyranose Rings 298

11.1.2 Conformation of Pyranose and Furanose Rings 300

11.1.3 Monosaccharides Are Joined to Alcohols and Amines Through Glycosidic Bonds 300

11.2 Complex Carbohydrates Are Formed by Linkage of Monosaccharides 301

11.2.1 Sucrose, Lactose, and Maltose Are the Common Disaccharides 302

11.2.2 Glycogen and Starch Are Mobilizable Stores of Glucose 302

11.2.3 Cellulose, the Major Structural Polymer of Plants, Consists of Linear Chains of Glucose Units 303

11.2.4 Glycosaminoglycans Are Anionic Polysaccharide Chains Made of Repeating Disaccharide Units 304

11.2.5 Specific Enzymes Are Responsible for Oligosaccharide Assembly	304
<b>11.3 Carbohydrates Can Be Attached to Proteins to Form Glycoproteins</b>	<b>306</b>
11.3.1 Carbohydrates May Be Linked to Proteins Through Asparagine ( <i>N</i> -Linked) or Through Serine or Threonine ( <i>O</i> -Linked) Residues	306
11.3.2 Protein Glycosylation Takes Place in the Lumen of the Endoplasmic Reticulum and the Golgi Complex	307
11.3.3 <i>N</i> -Linked Glycoproteins Acquire Their Initial Sugars from Dolichol Donors in the Endoplasmic Reticulum	308
11.3.4 Transport Vesicles Carry Proteins from the Endoplasmic Reticulum to the Golgi Complex for Further Glycosylation and Sorting	309
11.3.5 Mannose 6-phosphate Targets Lysosomal Enzymes to Their Destinations	310
11.3.6 Glucose Residues Are Added and Trimmed to Aid in Protein Folding	310
11.3.7 Oligosaccharides Can Be “Sequenced”	311
<b>11.4 Lectins Are Specific Carbohydrate-Binding Proteins</b>	<b>312</b>
11.4.1 Lectins Promote Interactions Between Cells	313
11.4.2 Influenza Virus Binds to Sialic Acid Residues	314

## **CHAPTER 12 Lipids and Cell Membranes** 319

<b>12.1 Many Common Features Underlie the Diversity of Biological Membranes</b>	<b>320</b>
<b>12.2 Fatty Acids Are Key Constituents of Lipids</b>	<b>320</b>

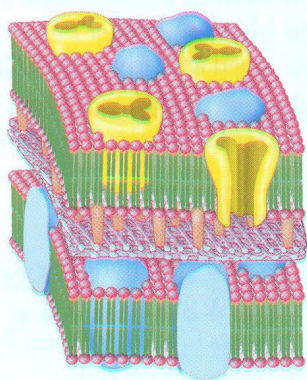

12.2.1 The Naming of Fats	320
12.2.2 Fatty Acids Vary in Chain Length and Degree of Unsaturation	321
<b>12.3 There Are Three Common Types of Membrane Lipids</b>	<b>322</b>
12.3.1 Phospholipids Are the Major Class of Membrane Lipids	322
12.3.2 Archaeal Membranes Are Built from Ether Lipids with Branched Chains	324
12.3.3 Membrane Lipids Can Also Include Carbohydrate Moieties	324

12.3.4 Cholesterol Is a Lipid Based on a Steroid Nucleus	325
12.3.5 A Membrane Lipid Is an Amphipathic Molecule Containing a Hydrophilic and a Hydrophobic Moiety	325
<b>12.4 Phospholipids and Glycolipids Readily Form Bimolecular Sheets in Aqueous Media</b>	<b>326</b>
12.4.1 Lipid Vesicles Can Be Formed from Phospholipids	327
12.4.2 Lipid Bilayers Are Highly Impermeable to Ions and Most Polar Molecules	328
<b>12.5 Proteins Carry Out Most Membrane Processes</b>	<b>329</b>
12.5.1 Proteins Associate with the Lipid Bilayer in a Variety of Ways	329
12.5.2 Proteins Interact with Membranes in a Variety of Ways	330
12.5.3 Some Proteins Associate with Membranes Through Covalently Attached Hydrophobic Groups	333
12.5.4 Transmembrane Helices Can Be Accurately Predicted from Amino Acid Sequences	334
<b>12.6 Lipids and Many Membrane Proteins Diffuse Rapidly in the Plane of the Membrane</b>	<b>335</b>
12.6.1 The Fluid Mosaic Model Allows Lateral Movement but Not Rotation Through the Membrane	336
12.6.2 Membrane Fluidity Is Controlled by Fatty Acid Composition and Cholesterol Content	337
12.6.3 All Biological Membranes Are Asymmetric	338
<b>12.7 Eukaryotic Cells Contain Compartments Bounded by Internal Membranes</b>	<b>338</b>
12.7.1 Proteins Are Targeted to Specific Compartments by Signal Sequences	339
12.7.2 Membrane Budding and Fusion Underlie Several Important Biological Processes	341

## **CHAPTER 13 Membrane Channels and Pumps** 345

<b>13.1 The Transport of Molecules Across a Membrane May Be Active or Passive</b>	<b>346</b>
13.1.1 Many Molecules Require Protein Transporters to Cross Membranes	346
13.1.2 Free Energy Stored in Concentration Gradients Can Be Quantified	347
<b>13.2 A Family of Membrane Proteins Uses ATP Hydrolysis to Pump Ions Across Membranes</b>	<b>347</b>
13.2.1 The Sarcoplasmic Reticulum $\text{Ca}^{2+}$ ATPase Is an Integral Membrane Protein	348
13.2.2 P-Type ATPases Are Evolutionarily Conserved and Play a Wide Range of Roles	350
13.2.3 Digitalis Specifically Inhibits the $\text{Na}^+$ - $\text{K}^+$ Pump by Blocking Its Dephosphorylation	350
<b>13.3 Multidrug Resistance and Cystic Fibrosis Highlight a Family of Membrane Proteins with ATP-Binding Cassette Domains</b>	<b>351</b>

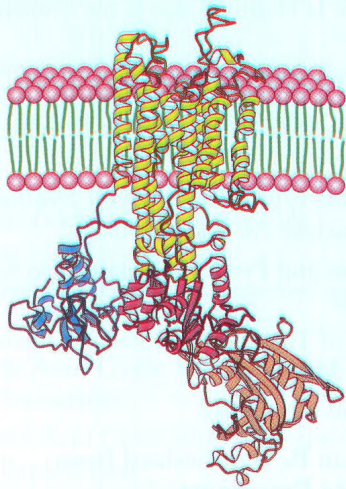

13.4 Secondary Transporters Use One Concentration Gradient to Power the Formation of Another	352
13.5 Specific Channels Can Rapidly Transport Ions Across Membranes	353
13.5.1 Patch-Clamp Conductance Measurements Reveal the Activities of Single Channels	354
13.5.2 Ion-Channel Proteins Are Built of Similar Units	355
13.5.3 Action Potentials Are Mediated by Transient Changes in Na <sup>+</sup> and K <sup>+</sup> Permeability	357
13.5.4 The Sodium Channel Is an Example of a Voltage-Gated Channel	358
13.5.5 Potassium Channels Are Homologous to the Sodium Channel	359
13.5.6 The Structure of a Potassium Channel Reveals the Basis of Rapid Ion Flow with Specificity	359
13.5.7 The Structure of the Potassium Channel Explains Its Rapid Rates of Transport	362
13.5.8 A Channel Can Be Inactivated by Occlusion of the Pore: The Ball-and-Chain Model	363
13.6 Gap Junctions Allow Ions and Small Molecules to Flow Between Communicating Cells	363

## PART II TRANSDUCING AND STORING ENERGY

<b>CHAPTER 14 Metabolism: Basic Concepts and Design</b>	<b>373</b>
14.0.1 Cells Transform Different Types of Energy	374
14.1 Metabolism Is Composed of Many Coupled, Interconnecting Reactions	374
14.1.1 A Thermodynamically Unfavorable Reaction Can Be Driven by a Favorable One	375
14.1.2 ATP Is the Universal Currency of Free Energy in Biological Systems	376
14.1.3 ATP Hydrolysis Drives Metabolism by Shifting the Equilibrium of Coupled Reactions	377
14.1.4 Structural Basis of the High Phosphoryl Transfer Potential of ATP	378

14.1.5 Phosphoryl Transfer Potential Is an Important Form of Cellular Energy Transformation	379
14.2 The Oxidation of Carbon Fuels Is an Important Source of Cellular Energy	380
14.2.1 High Phosphoryl Transfer Potential Compounds Can Couple Carbon Oxidation to ATP Synthesis	381
14.2.2 Ion Gradients Across Membranes Provide an Important Form of Cellular Energy That Can Be Coupled to ATP Synthesis	382
14.2.3 Stages in the Extraction of Energy from Foodstuffs	382
14.3 Metabolic Pathways Contain Many Recurring Motifs	383
14.3.1 Activated Carriers Exemplify the Modular Design and Economy of Metabolism	383
14.3.2 Key Reactions Are Reiterated Throughout Metabolism	386
14.3.3 Metabolic Processes Are Regulated in Three Principal Ways	390
14.3.4 Evolution of Metabolic Pathways	391

## CHAPTER 15 Signal-Transduction Pathways: An Introduction to Information Metabolism 395

15.0.1 Signal Transduction Depends on Molecular Circuits: An Overview	396
15.1 Seven-Transmembrane-Helix Receptors Change Conformation in Response to Ligand Binding and Activate G Proteins	398
15.1.1 Ligand Binding to 7TM Receptors Leads to the Activation of G Proteins	399
15.1.2 G Proteins Cycle Between GDP- and GTP-Bound Forms	399
15.1.3 Activated G Proteins Transmit Signals by Binding to Other Proteins	401
15.1.4 G Proteins Spontaneously Reset Themselves Through GTP Hydrolysis	402
15.1.5 Cyclic AMP Stimulates the Phosphorylation of Many Target Proteins by Activating Protein Kinase A	403
15.2 The Hydrolysis of Phosphatidyl Inositol Biphosphate by Phospholipase C Generates Two Messengers	403
15.2.1 Inositol 1,4,5-trisphosphate Opens Channels to Release Calcium Ions from Intracellular Stores	405
15.2.2 Diacylglycerol Activates Protein Kinase C, Which Phosphorylates Many Target Proteins	406
15.3 Calcium Ion Is a Ubiquitous Cytosolic Messenger	408
15.3.1 Ionophores Allow the Visualization of Changes in Calcium Concentration	408
15.3.2 Calcium Activates the Regulatory Protein Calmodulin, Which Stimulates Many Enzymes and Transporters	410
15.4 Some Receptors Dimerize in Response to Ligand Binding and Signal by Cross-Phosphorylation	411



15.4.1 Some Receptors Contain Tyrosine Kinase Domains Within Their Covalent Structures	414
15.4.2 Ras, Another Class of Signaling G Protein	415
<b>15.5 Defects in Signaling Pathways Can Lead to Cancer and Other Diseases</b>	<b>416</b>
15.5.1 Protein Kinase Inhibitors May Be Effective Anticancer Drugs	418
15.5.2 Cholera and Whooping Cough Are Due to Altered G-Protein Activity	418
<b>15.6 Recurring Features of Signal-Transduction Pathways Reveal Evolutionary Relationships</b>	<b>419</b>

## **CHAPTER 16 Glycolysis and Gluconeogenesis** 425

16.0.1 Glucose Is an Important Fuel for Most Organisms	426
16.0.2 Fermentations Provide Usable Energy in the Absence of Oxygen	426
<b>16.1 Glycolysis Is an Energy-Conversion Pathway in Many Organisms</b>	<b>428</b>
16.1.1 Hexokinase Traps Glucose in the Cell and Begins Glycolysis	428
16.1.2 The Formation of Fructose 1,6-bisphosphate from Glucose 6-phosphate	430
16.1.3 The Six-Carbon Sugar Is Cleaved into Two Three-Carbon Fragments by Aldolase	431
16.1.4 Triose Phosphate Isomerase Salvages a Three-Carbon Fragment	431
16.1.5 Energy Transformation: Phosphorylation Is Coupled to the Oxidation of Glyceraldehyde 3-phosphate by a Thioester Intermediate	433
16.1.6 The Formation of ATP from 1,3-Bisphosphoglycerate	435
16.1.7 The Generation of Additional ATP and the Formation of Pyruvate	435
16.1.8 Energy Yield in the Conversion of Glucose into Pyruvate	437



16.1.9 Maintaining Redox Balance: The Diverse Fates of Pyruvate	438
16.1.10 The Binding Site for NAD <sup>+</sup> Is Similar in Many Dehydrogenases	440
16.1.11 The Entry of Fructose and Galactose into Glycolysis	440
16.1.12 Many Adults Are Intolerant of Milk Because They Are Deficient in Lactase	442

16.1.13 Galactose Is Highly Toxic If the Transferase Is Missing	443
<b>16.2 The Glycolytic Pathway Is Tightly Controlled</b>	<b>443</b>
16.2.1 Phosphofructokinase Is the Key Enzyme in the Control of Glycolysis	444
16.2.2 A Regulated Bifunctional Enzyme Synthesizes and Degrades Fructose 2,6-bisphosphate	445
16.2.3 Hexokinase and Pyruvate Kinase Also Set the Pace of Glycolysis	447
16.2.4 A Family of Transporters Enables Glucose to Enter and Leave Animal Cells	448
16.2.5 Cancer and Glycolysis	449

## **16.3 Glucose Can Be Synthesized from Noncarbohydrate Precursors** 450

16.3.1 Gluconeogenesis Is Not a Reversal of Glycolysis	450
16.3.2 The Conversion of Pyruvate into Phosphoenolpyruvate Begins with the Formation of Oxaloacetate	452
16.3.3 Oxaloacetate Is Shuttled into the Cytosol and Converted into Phosphoenolpyruvate	454
16.3.4 The Conversion of Fructose 1,6-bisphosphate into Fructose 6-phosphate and Orthophosphate Is an Irreversible Step	454
16.3.5 The Generation of Free Glucose Is an Important Control Point	455
16.3.6 Six High-Energy Phosphate Bonds Are Spent in Synthesizing Glucose from Pyruvate	455

## **16.4 Gluconeogenesis and Glycolysis Are Reciprocally Regulated** 456

16.4.1 Substrate Cycles Amplify Metabolic Signals and Produce Heat	457
16.4.2 Lactate and Alanine Formed by Contracting Muscle Are Converted into Glucose by the Liver	458
16.4.3 Glycolysis and Gluconeogenesis Are Evolutionarily Intertwined	460

## **CHAPTER 17 The Citric Acid Cycle** 465

17.0.1 An Overview of the Citric Acid Cycle	466
<b>17.1 The Citric Acid Cycle Oxidizes Two-Carbon Units</b>	<b>467</b>
17.1.1 The Formation of Acetyl Coenzyme A from Pyruvate	467
17.1.2 Flexible Linkages Allow Lipoamide to Move Between Different Active Sites	470
17.1.3 Citrate Synthase Forms Citrate from Oxaloacetate and Acetyl Coenzyme A	472
17.1.4 Citrate Is Isomerized into Isocitrate	473
17.1.5 Isocitrate Is Oxidized and Decarboxylated to $\alpha$ -Ketoglutarate	474
17.1.6 Succinyl Coenzyme A Is Formed by the Oxidative Decarboxylation of $\alpha$ -Ketoglutarate	475
17.1.7 A High Phosphoryl-Transfer Potential Compound Is Generated from Succinyl Coenzyme A	475

17.1.8 Oxaloacetate Is Regenerated by the Oxidation of Succinate	477
17.1.9 Stoichiometry of the Citric Acid Cycle	478
<b>17.2 Entry to the Citric Acid Cycle and Metabolism Through It Are Controlled</b>	<b>480</b>
17.2.1 The Pyruvate Dehydrogenase Complex Is Regulated Allosterically and by Reversible Phosphorylation	480
17.2.2 The Citric Acid Cycle Is Controlled at Several Points	481
<b>17.3 The Citric Acid Cycle Is a Source of Biosynthetic Precursors</b>	<b>482</b>
17.3.1 The Citric Acid Cycle Must Be Capable of Being Rapidly Replenished	482
17.3.2 The Disruption of Pyruvate Metabolism Is the Cause of Beriberi and Poisoning by Mercury and Arsenic	483
17.3.3 Speculations on the Evolutionary History of the Citric Acid Cycle	484
<b>17.4 The Glyoxylate Cycle Enables Plants and Bacteria to Grow on Acetate</b>	<b>484</b>

---

## **CHAPTER 18 Oxidative Phosphorylation** **491**

<b>18.1 Oxidative Phosphorylation in Eukaryotes Takes Place in Mitochondria</b>	<b>492</b>
18.1.1 Mitochondria Are Bounded by a Double Membrane	492
18.1.2 Mitochondria Are the Result of an Endosymbiotic Event	493
<b>18.2 Oxidative Phosphorylation Is Dependent on Electron Transfer</b>	<b>494</b>
18.2.1 High-Energy Electrons: Redox Potentials and Free-Energy Changes	494
18.2.2 A 1.14-Volt Potential Difference Between NADH and O <sub>2</sub> Drives Electron Transport Through the Chain and Favors the Formation of a Proton Gradient	496
18.2.3 Electrons Can Be Transferred Between Groups That Are Not in Contact	497
<b>18.3 The Respiratory Chain Consists of Four Complexes: Three Proton Pumps and a Physical Link to the Citric Acid Cycle</b>	<b>498</b>

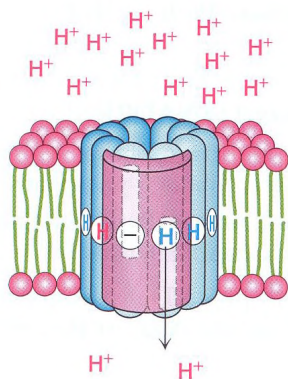

18.3.1 The High-Potential Electrons of NADH Enter the Respiratory Chain at NADH-Q Oxidoreductase	499
--------------------------------------------------------------------------------------------------	-----

18.3.2 Ubiquinol Is the Entry Point for Electrons from FADH <sub>2</sub> of Flavoproteins	501
18.3.3 Electrons Flow from Ubiquinol to Cytochrome <i>c</i> Through Q-Cytochrome <i>c</i> Oxidoreductase	501
18.3.4 Transmembrane Proton Transport: The Q Cycle	502
18.3.5 Cytochrome <i>c</i> Oxidase Catalyzes the Reduction of Molecular Oxygen to Water	503
18.3.6 Toxic Derivatives of Molecular Oxygen Such as Superoxide Radical Are Scavenged by Protective Enzymes	506
18.3.7 The Conformation of Cytochrome <i>c</i> Has Remained Essentially Constant for More Than a Billion Years	507
<b>18.4 A Proton Gradient Powers the Synthesis of ATP</b>	<b>507</b>
18.4.1 ATP Synthase Is Composed of a Proton-Conducting Unit and a Catalytic Unit	509
18.4.2 Proton Flow Through ATP Synthase Leads to the Release of Tightly Bound ATP: The Binding-Change Mechanism	509
18.4.3 The World's Smallest Molecular Motor: Rotational Catalysis	511
18.4.4 Proton Flow Around the <i>c</i> Ring Powers ATP Synthesis	511
18.4.5 ATP Synthase and G Proteins Have Several Common Features	513
<b>18.5 Many Shuttles Allow Movement Across the Mitochondrial Membranes</b>	<b>514</b>
18.5.1 Electrons from Cytosolic NADH Enter Mitochondria by Shuttles	514
18.5.2 The Entry of ADP into Mitochondria Is Coupled to the Exit of ATP by ATP-ADP Translocase	515
18.5.3 Mitochondrial Transporters for Metabolites Have a Common Tripartite Motif	516
<b>18.6 The Regulation of Oxidative Phosphorylation Is Governed Primarily by the Need for ATP</b>	<b>517</b>
18.6.1 The Complete Oxidation of Glucose Yields About 30 Molecules of ATP	517
18.6.2 The Rate of Oxidative Phosphorylation Is Determined by the Need for ATP	518
18.6.3 Oxidative Phosphorylation Can Be Inhibited at Many Stages	519
18.6.4 Regulated Uncoupling Leads to the Generation of Heat	519
18.6.5 Mitochondrial Diseases Are Being Discovered	520
18.6.6 Mitochondria Play a Key Role in Apoptosis	521
18.6.7 Power Transmission by Proton Gradients: A Central Motif of Bioenergetics	521

---

## **CHAPTER 19 The Light Reactions of Photosynthesis** **527**

19.0.1 Photosynthesis: An Overview	528
<b>19.1 Photosynthesis Takes Place in Chloroplasts</b>	<b>528</b>



20.5.2 A Deficiency of Glucose 6-phosphate Dehydrogenase Confers an Evolutionary Advantage in Some Circumstances	572
------------------------------------------------------------------------------------------------------------------	-----

---

## **CHAPTER 21 Glycogen Metabolism** **577**

21.0.1 An Overview of Glycogen Metabolism	578
<b>21.1 Glycogen Breakdown Requires the Interplay of Several Enzymes</b>	<b>579</b>
21.1.1 Phosphorylase Catalyzes the Phosphorolytic Cleavage of Glycogen to Release Glucose 1-phosphate	579
21.1.2 A Debranching Enzyme Also Is Needed for the Breakdown of Glycogen	580
21.1.3 Phosphoglucomutase Converts Glucose 1-phosphate into Glucose 6-phosphate	581
21.1.4 Liver Contains Glucose 6-phosphatase, a Hydrolytic Enzyme Absent from Muscle	581
21.1.5 Pyridoxal Phosphate Participates in the Phosphorolytic Cleavage of Glycogen	582
<b>21.2 Phosphorylase Is Regulated by Allosteric Interactions and Reversible Phosphorylation</b>	<b>583</b>

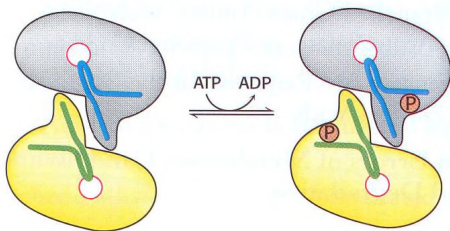

21.2.1 Muscle Phosphorylase Is Regulated by the Intracellular Energy Charge	583
21.2.2 Liver Phosphorylase Produces Glucose for Use by Other Tissues	585
21.2.3 Phosphorylase Kinase Is Activated by Phosphorylation and Calcium Ions	586
<b>21.3 Epinephrine and Glucagon Signal the Need for Glycogen Breakdown</b>	<b>586</b>
21.3.1 G Proteins Transmit the Signal for the Initiation of Glycogen Breakdown	586
21.3.2 Glycogen Breakdown Must Be Capable of Being Rapidly Turned Off	588
21.3.3 The Regulation of Glycogen Phosphorylase Became More Sophisticated As the Enzyme Evolved	588
<b>21.4 Glycogen Is Synthesized and Degraded by Different Pathways</b>	<b>589</b>
21.4.1 UDP-Glucose Is an Activated Form of Glucose	589
21.4.2 Glycogen Synthase Catalyzes the Transfer of Glucose from UDP-Glucose to a Growing Chain	589
21.4.3 A Branching Enzyme Forms $\alpha$ -1,6 Linkages	590
21.4.4 Glycogen Synthase Is the Key Regulatory Enzyme in Glycogen Synthesis	591
21.4.5 Glycogen Is an Efficient Storage Form of Glucose	591

<b>21.5 Glycogen Breakdown and Synthesis Are Reciprocally Regulated</b>	<b>592</b>
21.5.1 Protein Phosphatase 1 Reverses the Regulatory Effects of Kinases on Glycogen Metabolism	592
21.5.2 Insulin Stimulates Glycogen Synthesis by Activating Protein Phosphatase 1	593
21.5.3 Glycogen Metabolism in the Liver Regulates the Blood-Glucose Level	594
21.5.4 A Biochemical Understanding of Glycogen-Storage Diseases Is Possible	595

---

## **CHAPTER 22 Fatty Acid Metabolism** **601**

22.0.1 An Overview of Fatty Acid Metabolism	601
<b>22.1 Triacylglycerols Are Highly Concentrated Energy Stores</b>	<b>603</b>
22.1.1 Dietary Lipids Are Digested by Pancreatic Lipases	603
22.1.2 Dietary Lipids Are Transported in Chylomicrons	604
<b>22.2 The Utilization of Fatty Acids As Fuel Requires Three Stages of Processing</b>	<b>605</b>
22.2.1 Triacylglycerols Are Hydrolyzed by Cyclic AMP-Regulated Lipases	605
22.2.2 Fatty Acids Are Linked to Coenzyme A Before They Are Oxidized	606
22.2.3 Carnitine Carries Long-Chain Activated Fatty Acids into the Mitochondrial Matrix	607
22.2.4 Acetyl CoA, NADH, and FADH <sub>2</sub> Are Generated in Each Round of Fatty Acid Oxidation	607
22.2.5 The Complete Oxidation of Palmitate Yields 106 Molecules of ATP	609
<b>22.3 Certain Fatty Acids Require Additional Steps for Degradation</b>	<b>610</b>
22.3.1 An Isomerase and a Reductase Are Required for the Oxidation of Unsaturated Fatty Acids	610
22.3.2 Odd-Chain Fatty Acids Yield Propionyl Coenzyme A in the Final Thiolytic Step	611
22.3.3 Propionyl CoA Is Converted into Succinyl CoA in a Reaction That Requires Vitamin B <sub>12</sub>	611
22.3.4 Fatty Acids Are Also Oxidized in Peroxisomes	614
22.3.5 Ketone Bodies Are Formed from Acetyl Coenzyme A When Fat Breakdown Predominates	615
22.3.6 Ketone Bodies Are a Major Fuel in Some Tissues	616
22.3.7 Animals Cannot Convert Fatty Acids into Glucose	617
<b>22.4 Fatty Acids Are Synthesized and Degraded by Different Pathways</b>	<b>617</b>
22.4.1 The Formation of Malonyl Coenzyme A Is the Committed Step in Fatty Acid Synthesis	617
22.4.2 Intermediates in Fatty Acid Synthesis Are Attached to an Acyl Carrier Protein	618
22.4.3 The Elongation Cycle in Fatty Acid Synthesis	618

22.4.4 Fatty Acids Are Synthesized by a Multifunctional Enzyme Complex in Eukaryotes	620	23.4 Ammonium Ion Is Converted into Urea in Most Terrestrial Vertebrates	644
22.4.5 The Flexible Phosphopantetheinyl Unit of ACP Carries Substrate from One Active Site to Another	621	23.4.1 The Urea Cycle Begins with the Formation of Carbamoyl Phosphate	645
22.4.6 The Stoichiometry of Fatty Acid Synthesis	622	23.4.2 The Urea Cycle Is Linked to the Citric Acid Cycle	646
22.4.7 Citrate Carries Acetyl Groups from Mitochondria to the Cytosol for Fatty Acid Synthesis	622	23.4.3 The Evolution of the Urea Cycle	646
22.4.8 Sources of NADPH for Fatty Acid Synthesis	623	23.4.4 Inherited Defects of the Urea Cycle Cause Hyperammonemia and Can Lead to Brain Damage	647
22.4.9 Fatty Acid Synthase Inhibitors May Be Useful Drugs	623	23.4.5 Urea Is Not the Only Means of Disposing of Excess Nitrogen	648
22.4.10 Variations on a Theme: Polyketide and Nonribosomal Peptide Synthases Resemble Fatty Acid Synthase	624	<b>23.5 Carbon Atoms of Degraded Amino Acids Emerge As Major Metabolic Intermediates</b>	<b>649</b>
<b>22.5 Acetyl Coenzyme A Carboxylase Plays a Key Role in Controlling Fatty Acid Metabolism</b>	<b>624</b>	23.5.1 Pyruvate as an Entry Point into Metabolism	650
<b>22.6 Elongation and Unsaturation of Fatty Acids Are Accomplished by Accessory Enzyme Systems</b>	<b>626</b>	23.5.2 Oxaloacetate as an Entry point into Metabolism	650
22.6.1 Membrane-Bound Enzymes Generate Unsaturated Fatty Acids	626	23.5.3 Alpha-Ketoglutarate as an Entry Point into Metabolism	651
22.6.2 Eicosanoid Hormones Are Derived from Polyunsaturated Fatty Acids	626	23.5.4 Succinyl Coenzyme A Is a Point of Entry for Several Nonpolar Amino Acids	652
		23.5.5 Methionine Degradation Requires the Formation of a Key Methyl Donor, S-Adenosylmethionine	652
		23.5.6 The Branched-Chain Amino Acids Yield Acetyl CoA, Acetoacetate, or Propionyl CoA	652
		23.5.7 Oxygenases Are Required for the Degradation of Aromatic Amino Acids	654
<b>CHAPTER 23 Protein Turnover and Amino Acid Catabolism</b>	<b>633</b>	<b>23.6 Inborn Errors of Metabolism Can Disrupt Amino Acid Degradation</b>	<b>655</b>
<b>23.1 Proteins Are Degraded to Amino Acids</b>	<b>634</b>		
23.1.1 The Digestion and Absorption of Dietary Proteins	634		
23.1.2 Cellular Proteins Are Degraded at Different Rates	634		
<b>23.2 Protein Turnover Is Tightly Regulated</b>	<b>635</b>		
23.2.1 Ubiquitin Tags Proteins for Destruction	635		
23.2.2 The Proteasome Digests the Ubiquitin-Tagged Proteins	636		
23.2.3 Protein Degradation Can Be Used to a Regulate Biological Function	638		
23.2.4 The Ubiquitin Pathway and the Proteasome Have Prokaryotic Counterparts	638		
<b>23.3 The First Step in Amino Acid Degradation Is the Removal of Nitrogen</b>	<b>639</b>		
23.3.1 Alpha-Amino Groups Are Converted into Ammonium Ions by the Oxidative Deamination of Glutamate	639		
23.3.2 Pyridoxal Phosphate Forms Schiff-Base Intermediates in Aminotransferases	640		
23.3.3 Aspartate Aminotransferase Is a Member of a Large and Versatile Family of Pyridoxal-Dependent Enzymes	642		
23.3.4 Serine and Threonine Can Be Directly Deaminated	643		
23.3.5 Peripheral Tissues Transport Nitrogen to the Liver	643		
		<b>PART III SYNTHESIZING THE MOLECULES OF LIFE</b>	
		<b>CHAPTER 24 The Biosynthesis of Amino Acids</b>	<b>665</b>
		24.0.1 An Overview of Amino Acid Synthesis	666
		<b>24.1 Nitrogen Fixation: Microorganisms Use ATP and a Powerful Reductant to Reduce Atmospheric Nitrogen to Ammonia</b>	<b>666</b>
		24.1.1 The Iron–Molybdenum Cofactor of Nitrogenase Binds and Reduces Atmospheric Nitrogen	667
		24.1.2 Ammonium Ion Is Assimilated into an Amino Acid Through Glutamate and Glutamine	668
		<b>24.2 Amino Acids Are Made from Intermediates of the Citric Acid Cycle and Other Major Pathways</b>	<b>670</b>
		24.2.1 Human Beings Can Synthesize Some Amino Acids But Must Obtain Others from The Diet	671
		24.2.2 A Common Step Determines the Chirality of All Amino Acids	671
		24.2.3 An Adenylated Intermediate Is Required to Form Asparagine from Aspartate	673
		24.2.4 Glutamate Is the Precursor of Glutamine, Proline, and Arginine	673



24.2.5 Serine, Cysteine, and Glycine Are Formed from 3-Phosphoglycerate	674
24.2.6 Tetrahydrofolate Carries Activated One-Carbon Units at Several Oxidation Levels	674
24.2.7 S-Adenosylmethionine Is the Major Donor of Methyl Groups	676
24.2.8 Cysteine Is Synthesized from Serine and Homocysteine	678
24.2.9 High Homocysteine Levels Are Associated with Vascular Disease	678
24.2.10 Shikimate and Chorismate Are Intermediates in the Biosynthesis of Aromatic Amino Acids	678
24.2.11 Tryptophan Synthetase Illustrates Substrate Channeling in Enzymatic Catalysis	681
<b>24.3 Amino Acid Biosynthesis Is Regulated by Feedback Inhibition</b>	<b>681</b>
24.3.1 Branched Pathways Require Sophisticated Regulation	682
24.3.2 The Activity of Glutamine Synthetase Is Modulated by an Enzymatic Cascade	684
<b>24.4 Amino Acids Are Precursors of Many Biomolecules</b>	<b>685</b>
24.4.1 Glutathione, a Gamma-Glutamyl Peptide, Serves As a Sulfhydryl Buffer and an Antioxidant	686
24.4.2 Nitric Oxide, a Short-Lived Signal Molecule, Is Formed from Arginine	686
24.4.3 Mammalian Porphyrins Are Synthesized from Glycine and Succinyl Coenzyme A	687
24.4.4 Porphyrins Accumulate in Some Inherited Disorders of Porphyrin Metabolism	688

## CHAPTER 25 Nucleotide Biosynthesis 693

25.0.1 Overview of Nucleotide Biosynthesis and Nomenclature	694
<b>25.1 In de Novo Synthesis, the Pyrimidine Ring Is Assembled from Bicarbonate, Aspartate, and Glutamine</b>	<b>694</b>
25.1.1 Bicarbonate and Other Oxygenated Carbon Compounds Are Activated by Phosphorylation	695
25.1.2 The Side Chain of Glutamine Can Be Hydrolyzed to Generate Ammonia	695
25.1.3 Intermediates Can Move Between Active Sites by Channeling	696

25.1.4 Orotate Acquires a Ribose Ring from PRPP to Form a Pyrimidine Nucleotide and Is Converted into Uridylate	696
25.1.5 Nucleotide Mono-, Di-, and Triphosphates Are Interconvertible	697
25.1.6 CTP Is Formed by Amination of UTP	697
<b>25.2 Purine Bases Can Be Synthesized de Novo or Recycled by Salvage Pathways</b>	<b>698</b>

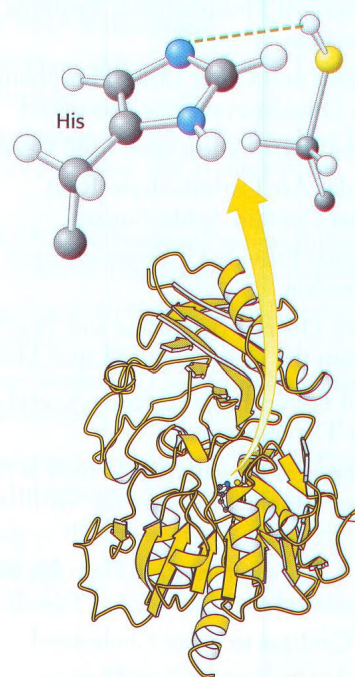

25.2.1 Salvage Pathways Economize Intracellular Energy Expenditure	698
25.2.2 The Purine Ring System Is Assembled on Ribose Phosphate	698
25.2.3 The Purine Ring Is Assembled by Successive Steps of Activation by Phosphorylation Followed by Displacement	699
25.2.4 AMP and GMP Are Formed from IMP	701
<b>25.3 Deoxyribonucleotides Are Synthesized by the Reduction of Ribonucleotides Through a Radical Mechanism</b>	<b>702</b>
25.3.1 Thymidylate Is Formed by the Methylation of Deoxyuridylate	704
25.3.2 Dihydrofolate Reductase Catalyzes the Regeneration of Tetrahydrofolate, a One-Carbon Carrier	705
25.3.3 Several Valuable Anticancer Drugs Block the Synthesis of Thymidylate	705
<b>25.4 Key Steps in Nucleotide Biosynthesis Are Regulated by Feedback Inhibition</b>	<b>707</b>
<b>25.5 NAD<sup>+</sup>, FAD, and Coenzyme A Are Formed from ATP</b>	<b>708</b>
<b>25.6 Disruptions in Nucleotide Metabolism Can Cause Pathological Conditions</b>	<b>709</b>
25.6.1 Purines Are Degraded to Urate in Human Beings	709

25.6.2 Lesch-Nyhan Syndrome Is a Dramatic Consequence of Mutations in a Salvage-Pathway Enzyme	710	26.4.7 Vitamin D Is Derived from Cholesterol by the Ring-Splitting Activity of Light	737
<b>CHAPTER 26 The Biosynthesis of Membrane Lipids and Steroids</b>		<b>CHAPTER 27 DNA Replication, Recombination, and Repair</b>	
<b>26.1 Phosphatidate Is a Common Intermediate in the Synthesis of Phospholipids and Triacylglycerols</b>	<b>716</b>	<b>27.1 DNA Can Assume a Variety of Structural Forms</b>	<b>745</b>
26.1.1 The Synthesis of Phospholipids Requires an Activated Intermediate	716	27.1.1 A-DNA Is a Double Helix with Different Characteristics from Those of the More Common B-DNA	747
26.1.2 Plasmalogens and Other Ether Phospholipids Are Synthesized from Dihydroxyacetone Phosphate	718	27.1.2 The Major and Minor Grooves Are Lined by Sequence-Specific Hydrogen-Bonding Groups	748
26.1.3 Sphingolipids Are Synthesized from Ceramide	720	27.1.3 The Results of Studies of Single Crystals of DNA Revealed Local Variations in DNA Structure	748
26.1.4 Gangliosides Are Carbohydrate-Rich Sphingolipids That Contain Acidic Sugars	721	27.1.4 Z-DNA Is a Left-Handed Double Helix in Which Backbone Phosphates Zigzag	749
26.1.5 Sphingolipids Provide Diversity in Lipid Structure and Function	721	<b>27.2 DNA Polymerases Require a Template and a Primer</b>	<b>750</b>
26.1.6 Respiratory Distress Syndrome and Tay-Sachs Disease Result from the Disruption of Lipid Metabolism	721		
<b>26.2 Cholesterol Is Synthesized from Acetyl Coenzyme A in Three Stages</b>	<b>722</b>		
26.2.1 The Synthesis of Mevalonate, Which Is Activated as Isopentyl Pyrophosphate, Initiates the Synthesis of Cholesterol	723		
26.2.2 Squalene (C <sub>30</sub> ) Is Synthesized from Six Molecules of Isopentyl Pyrophosphate (C <sub>5</sub> )	725		
26.2.3 Squalene Cyclizes to Form Cholesterol	725		
<b>26.3 The Complex Regulation of Cholesterol Biosynthesis Takes Place at Several Levels</b>	<b>726</b>		
26.3.1 Lipoproteins Transport Cholesterol and Triacylglycerols Throughout the Organism	727		
26.3.2 The Blood Levels of Certain Lipoproteins Can Serve Diagnostic Purposes	728		
26.3.3 Low-Density Lipoproteins Play a Central Role in Cholesterol Metabolism	728		
26.3.4 The LDL Receptor Is a Transmembrane Protein with Five Different Functional Regions	730		
26.3.5 The Absence of the LDL Receptor Leads to Hypercholesterolemia and Atherosclerosis	730	27.2.1 All DNA Polymerases Have Structural Features in Common	750
26.3.6 The Clinical Management of Cholesterol Levels Can Be Understood at a Biochemical Level	731	27.2.2 Two Bound Metal Ions Participate in the Polymerase Reaction	751
<b>26.4 Important Derivatives of Cholesterol Include Bile Salts and Steroid Hormones</b>	<b>731</b>	27.2.3 The Specificity of Replication Is Dictated by Hydrogen Bonding and Complementarity of Shape Between Bases	751
26.4.1 The Nomenclature of Steroid Hormones	733	27.2.4 Many Polymerases Proofread the Newly Added Bases and Excise Errors	752
26.4.2 Steroids Are Hydroxylated by Cytochrome P450 Monooxygenases That Utilize NADPH and O <sub>2</sub>	734	27.2.5 The Separation of DNA Strands Requires Specific Helicases and ATP Hydrolysis	753
26.4.3 The Cytochrome P450 System Is Widespread and Performs a Protective Enzyme Function	735	<b>27.3 Double-Stranded DNA Can Wrap Around Itself to Form Supercoiled Structures</b>	<b>754</b>
26.4.4 Pregnenolone, a Precursor for Many Other Steroids, Is Formed from Cholesterol by Cleavage of Its Side Chain	735	27.3.1 The Linking Number of DNA, a Topological Property, Determines the Degree of Supercoiling	754
26.4.5 The Synthesis of Progesterone and Corticosteroids from Pregnenolone	735	27.3.2 Helical Twist and Superhelical Writhe Are Correlated with Each Other Through the Linking Number	755
26.4.6 The Synthesis of Androgens and Estrogens from Pregnenolone	736	27.3.3 Type I Topoisomerases Relax Supercoiled Structures	756
		27.3.4 Type II Topoisomerases Can Introduce Negative Supercoils Through Coupling to ATP Hydrolysis	757
		<b>27.4 DNA Replication of Both Strands Proceeds Rapidly from Specific Start Sites</b>	<b>759</b>

27.4.1 An RNA Primer Synthesized by Primase Enables DNA Synthesis to Begin	760	28.1.7 The Rho Protein Helps Terminate the Transcription of Some Genes	789
27.4.2 One Strand of DNA Is Made Continuously, Whereas the Other Strand Is Synthesized in Fragments	761	28.1.8 Precursors of Transfer and Ribosomal RNA Are Cleaved and Chemically Modified After Transcription	790
27.4.3 DNA Ligase Joins Ends of DNA in Duplex Regions	761	28.1.9 Antibiotic Inhibitors of Transcription	791
27.4.4 DNA Replication Requires Highly Processive Polymerases	762	<b>28.2 Eukaryotic Transcription and Translation Are Separated in Space and Time</b>	<b>792</b>
27.4.5 The Leading and Lagging Strands Are Synthesized in a Coordinated Fashion	763	28.2.1 RNA in Eukaryotic Cells Is Synthesized by Three Types of RNA Polymerase	793
27.4.6 DNA Synthesis Is More Complex in Eukaryotes Than in Prokaryotes	764	28.2.2 Cis- and Trans-Acting Elements: Locks and Keys of Transcription	794
27.4.7 Telomeres Are Unique Structures at the Ends of Linear Chromosomes	765	28.2.3 Most Promoters for RNA Polymerase II Contain a TATA Box Near the Transcription Start Site	794
27.4.8 Telomeres Are Replicated by Telomerase, a Specialized Polymerase That Carries Its Own RNA Template	765	28.2.4 The TATA-Box-Binding Protein Initiates the Assembly of the Active Transcription Complex	795
<b>27.5 Double-Stranded DNA Molecules with Similar Sequences Sometimes Recombine</b>	<b>766</b>	28.2.5 Multiple Transcription Factors Interact with Eukaryotic Promoters	796
27.5.1 Recombination Reactions Proceed Through Holliday Junction Intermediates	766	28.2.6 Enhancer Sequences Can Stimulate Transcription at Start Sites Thousand of Bases Away	797
27.5.2 Recombinases Are Evolutionarily Related to Topoisomerases	768	<b>28.3 The Transcription Products of All Three Eukaryotic Polymerases Are Processed</b>	<b>797</b>
<b>27.6 Mutations Are Produced by Several Types of Changes in the Base Sequence of DNA</b>	<b>768</b>	28.3.1 The Ends of the Pre-mRNA Transcript Acquire a 5' Cap and a 3' Poly(A) Tail	798
27.6.1 Some Chemical Mutagens Are Quite Specific	769	28.3.2 RNA Editing Changes the Proteins Encoded by mRNA	798
27.6.2 Ultraviolet Light Produces Pyrimidine Dimers	770	28.3.3 Splice Sites in mRNA Precursors Are Specified by Sequences at the Ends of Introns	799
27.6.3 A Variety of DNA-Repair Pathways Are Utilized	770	28.3.4 Splicing Consists of Two Transesterification Reactions	800
27.6.4 The Presence of Thymine Instead of Uracil in DNA Permits the Repair of Deaminated Cytosine	771	28.3.5 Small Nuclear RNAs in Spliceosomes Catalyze the Splicing of mRNA Precursors	801
27.6.5 Many Cancers Are Caused by Defective Repair of DNA	772	28.3.6 Some Pre-mRNA Molecules Can Be Spliced in Alternative Ways to Yield Different mRNAs	803
27.6.6 Some Genetic Diseases Are Caused by the Expansion of Repeats of Three Nucleotides	773	<b>28.4 The Discovery of Catalytic RNA Was Revealing in Regard to Both Mechanism and Evolution</b>	<b>804</b>
27.6.7 Many Potential Carcinogens Can Be Detected by Their Mutagenic Action on Bacteria	773		
<hr/>		<hr/>	
<b>CHAPTER 28 RNA Synthesis and Splicing</b>	<b>781</b>	<b>CHAPTER 29 Protein Synthesis</b>	<b>813</b>
28.0.1 An Overview of RNA Synthesis	782	<b>29.1 Protein Synthesis Requires the Translation of Nucleotide Sequences into Amino Acid Sequences</b>	<b>814</b>
<b>28.1 Transcription Is Catalyzed by RNA Polymerase</b>	<b>783</b>	29.1.1 The Synthesis of Long Proteins Requires a Low Error Frequency	814
28.1.1 Transcription is Initiated at Promoter Sites on the DNA Template	784	29.1.2 Transfer RNA Molecules Have a Common Design	815
28.1.2 Sigma Subunits of the RNA Polymerase Recognize Promoter Sites	785	29.1.3 The Activated Amino Acid and the Anticodon of tRNA Are at Opposite Ends of the L-Shaped Molecule	817
28.1.3 RNA Polymerase Must Unwind the Template Double Helix for Transcription to Take Place	786	<b>29.2 Aminoacyl-Transfer RNA Synthetases Read the Genetic Code</b>	<b>817</b>
28.1.4 RNA Chains Are Formed de Novo and Grow in the 5'-to-3' Direction	786	29.2.1 Amino Acids Are First Activated by Adenylation	818
28.1.5 Elongation Takes Place at Transcription Bubbles That Move Along the DNA Template	787		
28.1.6 An RNA Hairpin Followed by Several Uracil Residues Terminates the Transcription of Some Genes	788		



29.2.2 Aminoacyl-tRNA Synthetases Have Highly Discriminating Amino Acid Activation Sites	819
29.2.3 Proofreading by Aminoacyl-tRNA Synthetases Increases the Fidelity of Protein Synthesis	820
29.2.4 Synthetases Recognize the Anticodon Loops and Acceptor Stems of Transfer RNA Molecules	820
29.2.5 Aminoacyl-tRNA Synthetases Can Be Divided into Two Classes	822
<b>29.3 A Ribosome Is a Ribonucleoprotein Particle (70S) Made of a Small (30S) and a Large (50S) Subunit</b>	<b>823</b>

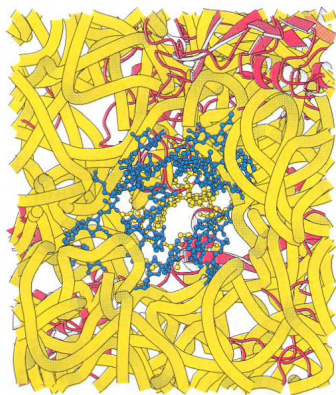

29.3.1 Ribosomal RNAs (5S, 16S, and 23S rRNA) Play a Central Role in Protein Synthesis	824
29.3.2 Proteins Are Synthesized in the Amino-to-Carboxyl Direction	826
29.3.3 Messenger RNA Is Translated in the 5'-to-3' Direction	826
29.3.4 The Start Signal Is AUG (or GUG) Preceded by Several Bases That Pair with 16S rRNA	827
29.3.5 Bacterial Protein Synthesis Is Initiated by Formylmethionyl Transfer RNA	828
29.3.6 Ribosomes Have Three tRNA-Binding Sites That Bridge the 30S and 50S Subunits	828
29.3.7 The Growing Polypeptide Chain Is Transferred Between tRNAs on Peptide-Bond Formation	829
29.3.8 Only the Codon–Anticodon Interactions Determine the Amino Acid That Is Incorporated	831
29.3.9 Some Transfer RNA Molecules Recognize More Than One Codon Because of Wobble in Base Pairing	832
<b>29.4 Protein Factors Play Key Roles in Protein Synthesis</b>	<b>833</b>
29.4.1 Formylmethionyl-tRNA <sub>f</sub> Is Placed in the P Site of the Ribosome During Formation of the 70S Initiation Complex	833
29.4.2 Elongation Factors Deliver Aminoacyl-tRNA to the Ribosome	834
29.4.3 The Formation of a Peptide Bond Is Followed by the GTP-Driven Translocation of tRNAs and mRNA	834
29.4.4 Protein Synthesis Is Terminated by Release Factors That Read Stop Codons	835
<b>29.5 Eukaryotic Protein Synthesis Differs from Prokaryotic Protein Synthesis Primarily in Translation Initiation</b>	<b>837</b>

29.5.1 Many Antibiotics Work by Inhibiting Protein Synthesis	838
29.5.2 Diphtheria Toxin Blocks Protein Synthesis in Eukaryotes by Inhibiting Translocation	839

## CHAPTER 30 The Integration of Metabolism 845

<b>30.1 Metabolism Consists of Highly Interconnected Pathways</b>	<b>845</b>
30.1.1 Recurring Motifs in Metabolic Regulation	846
30.1.2 Major Metabolic Pathways and Control Sites	847
30.1.3 Key Junctions: Glucose 6-phosphate, Pyruvate, and Acetyl CoA	849
<b>30.2 Each Organ Has a Unique Metabolic Profile</b>	<b>851</b>
<b>30.3 Food Intake and Starvation Induce Metabolic Change</b>	<b>854</b>
30.3.1 Metabolic Adaptations in Prolonged Starvation Minimize Protein Degradation	856
30.3.2 Metabolic Derangements in Diabetes Result from Relative Insulin Insufficiency and Glucagon Excess	858
30.3.3 Caloric Homeostasis: A Means of Regulating Body Weight	859
<b>30.4 Fuel Choice During Exercise Is Determined by Intensity and Duration of Activity</b>	<b>860</b>
<b>30.5 Ethanol Alters Energy Metabolism in the Liver</b>	<b>861</b>

## CHAPTER 31 The Control of Gene Expression 867

<b>31.1 Prokaryotic DNA-Binding Proteins Bind Specifically to Regulatory Sites in Operons</b>	<b>868</b>
31.1.1 An Operon Consists of Regulatory Elements and Protein-Encoding Genes	869
31.1.2 The <i>lac</i> Operator Has a Symmetric Base Sequence	870
31.1.3 The <i>lac</i> Repressor Protein in the Absence of Lactose Binds to the Operator and Blocks Transcription	870
31.1.4 Ligand Binding Can Induce Structural Changes in Regulatory Proteins	871
31.1.5 The Operon Is a Common Regulatory Unit in Prokaryotes	872
31.1.6 Transcription Can Be Stimulated by Proteins That Contact RNA Polymerase	873
31.1.7 The Helix-Turn-Helix Motif Is Common to Many Prokaryotic DNA-Binding Proteins	873
<b>31.2 The Greater Complexity of Eukaryotic Genomes Requires Elaborate Mechanisms for Gene Regulation</b>	<b>874</b>
31.2.1 Nucleosomes Are Complexes of DNA and Histones	875
31.2.2 Eukaryotic DNA Is Wrapped Around Histones to Form Nucleosomes	876
31.2.3 The Control of Gene Expression Requires Chromatin Remodeling	877

31.2.4 Enhancers Can Stimulate Transcription by Perturbing Chromatin Structure 878

31.2.5 The Modification of DNA Can Alter Patterns of Gene Expression 878

**31.3 Transcriptional Activation and Repression Are Mediated by Protein–Protein Interactions 879**

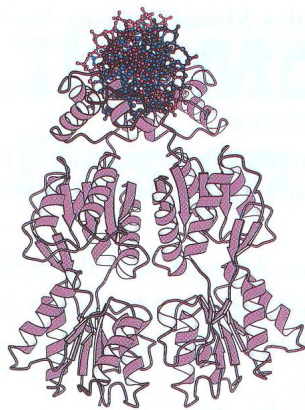

31.3.1 Steroids and Related Hydrophobic Molecules Pass Through Membranes and Bind to DNA-Binding Receptors 879

31.3.2 Nuclear Hormone Receptors Regulate Transcription by Recruiting Coactivators and Corepressors to the Transcription Complex 881

31.3.3 Steroid-Hormone Receptors Are Targets for Drugs 883

31.3.4 Chromatin Structure Is Modulated Through Covalent Modifications of Histone Tails 884

31.3.5 Histone Deacetylases Contribute to Transcriptional Repression 885

31.3.6 Ligand Binding to Membrane Receptors Can Regulate Transcription Through Phosphorylation Cascades 886

31.3.7 Chromatin Structure Effectively Decreases the Size of the Genome 887

**31.4 Gene Expression Can Be Controlled at Posttranscriptional Levels 887**

31.4.1 Attenuation Is a Prokaryotic Mechanism for Regulating Transcription Through Modulation of Nascent RNA Secondary Structure 887

31.4.2 Genes Associated with Iron Metabolism Are Translationally Regulated in Animals 888

**PART IV RESPONDING TO ENVIRONMENTAL CHANGES**

**CHAPTER 32 Sensory Systems 897**

**32.1 A Wide Variety of Organic Compounds Are Detected by Olfaction 898**

32.1.1 Olfaction Is Mediated by an Enormous Family of Seven-Transmembrane-Helix Receptors 899

32.1.2 Odorants Are Decoded by a Combinatorial Mechanism 901

32.1.3 Functional Magnetic Resonance Imaging Reveals Regions of the Brain Processing Sensory Information 902

**32.2 Taste Is a Combination of Senses That Function by Different Mechanisms 903**

32.2.1 Sequencing the Human Genome Led to the Discovery of a Large Family of 7TM Bitter Receptors 904

32.2.2 A Family of 7TM Receptors Respond to Sweet Compounds 906

32.2.3 Salty Tastes Are Detected Primarily by the Passage of Sodium Ions Through Channels 906

32.2.4 Sour Tastes Arise from the Effects of Hydrogen Ions (Acids) on Channels 906

32.2.5 Umami, the Taste of Glutamate, Is Detected by a Specialized Form of Glutamate Receptor 907

**32.3 Photoreceptor Molecules in the Eye Detect Visible Light 907**

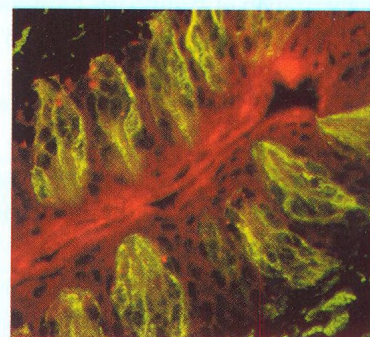

32.3.1 Rhodopsin, a Specialized 7TM Receptor, Absorbs Visible Light 908

32.3.2 Light Absorption Induces a Specific Isomerization of Bound 11-*cis*-Retinal 909

32.3.3 Light-Induced Lowering of the Calcium Level Coordinates Recovery 910

32.3.4 Color Vision Is Mediated by Three Cone Receptors That Are Homologs of Rhodopsin 911

32.3.5 Rearrangements in the Genes for the Green and Red Pigments Lead to “Color Blindness” 912

**32.4 Hearing Depends on the Speedy Detection of Mechanical Stimuli 913**

32.4.1 Hair Cells Use a Connected Bundle of Stereocilia to Detect Tiny Motions 913

32.4.2 Mechanosensory Channels Have Been Identified in *Drosophila* and Bacteria 914

**32.5 Touch Includes the Sensing of Pressure, Temperature, and Other Factors 915**

32.5.1 Studies of Capsaicin, the Active Ingredient in “Hot” Peppers, Reveal a Receptor for Sensing High Temperatures and Other Painful Stimuli 915

32.5.2 Subtle Sensory Systems Detect Other Environmental Factors Such as Earth’s Magnetic Field 917

**CHAPTER 33 The Immune System 921**

33.0.1 The Immune System Adapts, Using the Principles of Evolution 921

**33.1 Antibodies Possess Distinct Antigen-Binding and Effector Units 922**

